

Technical Manual
Of
Intel Bay Trail Series CPU
Based IPC M/B

NO. G03-NF533-F

Revision: 1.0

Release date: August 14, 2015

Trademark:

- * Specifications and Information contained in this documentation are furnished for information use only, and are subject to change at any time without notice, and should not be construed as a commitment by manufacturer.

Environmental Protection Announcement

Do not dispose this electronic device into the trash while discarding. To minimize pollution and ensure environment protection of mother earth, please recycle.



TABLE OF CONTENT

ENVIRONMENTAL SAFETY INSTRUCTION	iv
USER'S NOTICE	v
MANUAL REVISION INFORMATION	v
ITEM CHECKLIST	v
CHAPTER 1 INTRODUCTION OF THE MOTHERBOARD	
1-1 FEATURE OF MOTHERBOARD	1
1-2 SPECIFICATION	2
1-3 LAYOUT DIAGRAM	3
CHAPTER 2 HARDWARE INSTALLATION	
2-1 JUMPER SETTING	8
2-2 CONNECTORS AND HEADERS	11
2-2-1 CONNECTORS	11
2-2-2 HEADERS	14
CHAPTER 3 INTRODUCING BIOS	
3-1 ENTERING SETUP	19
3-2 BIOS MENU SCREEN	20
3-3 FUNCTION KEYS	20
3-4 GETTING HELP	21
3-5 MEMU BARS	21
3-6 MAIN MENU	22
3-7 ADVANCED MENU	23
3-8 CHIPSET MENU	33
3-9 SECURITY MENU	35
3-10 BOOT MENU	36
3-11 SAVE & EXIT MENU	37



Environmental Safety Instruction

- Avoid the dusty, humidity and temperature extremes. Do not place the product in any area where it may become wet.
- 0 to 60 centigrade is the suitable temperature. (The figure comes from the request of the main chipset)
- Generally speaking, dramatic changes in temperature may lead to contact malfunction and crackles due to constant thermal expansion and contraction from the 'welding spots' that connect components and PCB. Computer should go through an adaptive phase before it boots when it is moved from a cold environment to a warmer one to avoid condensation phenomenon. These water drops attached on PCB or the surface of the components can bring about phenomena as minor as computer instability resulted from corrosion and oxidation from components and PCB or as major as short circuit that can burn the components. Suggest starting the computer until the temperature goes up.
- The increasing temperature of the capacitor may decrease the life of computer. Using the close case may decrease the life of other device because the higher temperature in the inner of the case.
- Attention to the heat sink when you over-clocking. The higher temperature may decrease the life of the device and burned the capacitor.

USER'S NOTICE

COPYRIGHT OF THIS MANUAL BELONGS TO THE MANUFACTURER. NO PART OF THIS MANUAL, INCLUDING THE PRODUCTS AND SOFTWARE DESCRIBED IN IT MAY BE REPRODUCED, TRANSMITTED OR TRANSLATED INTO ANY LANGUAGE IN ANY FORM OR BY ANY MEANS WITHOUT WRITTEN PERMISSION OF THE MANUFACTURER.

THIS MANUAL CONTAINS ALL INFORMATION REQUIRED TO USE THIS MOTHER-BOARD SERIES AND WE DO ASSURE THIS MANUAL MEETS USER'S REQUIREMENT BUT WILL CHANGE, CORRECT ANY TIME WITHOUT NOTICE. MANUFACTURER PROVIDES THIS MANUAL "AS IS" WITHOUT WARRANTY OF ANY KIND, AND WILL NOT BE LIABLE FOR ANY INDIRECT, SPECIAL, INCIDENTAL OR CONSEQUENTIAL DAMAGES (INCLUDING DAMAGES FOR LOSS OF PROFIT, LOSS OF BUSINESS, LOSS OF USE OF DATA, INTERRUPTION OF BUSINESS AND THE LIKE).

PRODUCTS AND CORPORATE NAMES APPEARING IN THIS MANUAL MAY OR MAY NOT BE REGISTERED TRADEMARKS OR COPYRIGHTS OF THEIR RESPECTIVE COMPANIES, AND THEY ARE USED ONLY FOR IDENTIFICATION OR EXPLANATION AND TO THE OWNER'S BENEFIT, WITHOUT INTENT TO INFRINGE.

Manual Revision Information

Reversion	Revision History	Date
1.0	First Edition	August 14, 2015

Item Checklist

- Motherboard
- User's Manual
- CD for motherboard utilities
- Cable(s)

Chapter 1

Introduction of the Motherboard

1-1 Feature of Motherboard

- Onboard Intel® Bay Trail Series Processor, with low power consumption never denies high performance
- On Board SAMSUNG 4GBytes DDRIII DRAM
- Support 1 * SATAII (3Gb/s) Device
- Support 1* full-size m-SATA (***share with Mini-PCIE***)
- Support 3* full-size Mini-PCIE connector(***one share with MSATA***)
- Support USB 3.0 data transport demand
- Support 4* RJ-45 LAN port
- Support CPU Over-Temperature protection
- Support CPU Over-Current/Under Voltage protection
- Support CPU Smart FAN
- Compliance with ErP standard
- Support Watchdog function

1-2 Specification

Spec	Description
Design	<ul style="list-style-type: none"> ● 8- layer; PCB size: 14.8 x 10.2 cm
Embedded CPU	<ul style="list-style-type: none"> ● Integrated with Intel[®] Bay Trail-D/M/I series CPU
Memory	<ul style="list-style-type: none"> ● Onboard 4GBytes Samsung DDRIII DRAM
Expansion Slot	<ul style="list-style-type: none"> ● 2* Full-size Mini-PCIE slot (MPE1/MPE2) ● 1* Full-size Mini-PCIE/MSATA slot (MMPE1, share with MSATA slot) ● 1* SIM card slot
LAN Chip	<ul style="list-style-type: none"> ● Integrated with 4* Intel I211AT PCI-E Gigabit LAN chip ● Support Fast Ethernet LAN function of providing 10/100/1000Mbps Ethernet data transfer rate
Storage	<ul style="list-style-type: none"> ● 1*SATAII 3G/s port ● 1* Full-size MSATA slot (MMPE1, share with Mini-PCIE slot)
BIOS	<ul style="list-style-type: none"> ● AMI 64MB Flash ROM
Rear I/O	<ul style="list-style-type: none"> ● 1* 12V DC-in power Jack ● 1* USB 3.0 port ● 1* USB 2.0 port ● 4* RJ-45 LAN port ● 1* RS232 serial port (COM1)
Internal I/O	<ul style="list-style-type: none"> ● 1* 2-Pin internal 12V DC-in power connector ● 1* SATA Power-out connector ● 1* CPUFAN header ● 1* Front panel header ● 1* Speaker & Power LED header ● 1* LAN LED activity header ● 1* 9-pin USB 2.0 header (Expansible to 2* USB 2.0 ports) ● 1* RS232(/422/485) serial port header(COM2, RS422/485)

	<p>optional by order)</p> <ul style="list-style-type: none">● 1* PS/2 keyboard & mouse header● 1* SMBUS header● 1* GPIO_CON header● 1* Front panel VGA header
--	---

1-3 Layout Diagram

Rear IO Panel Diagram:

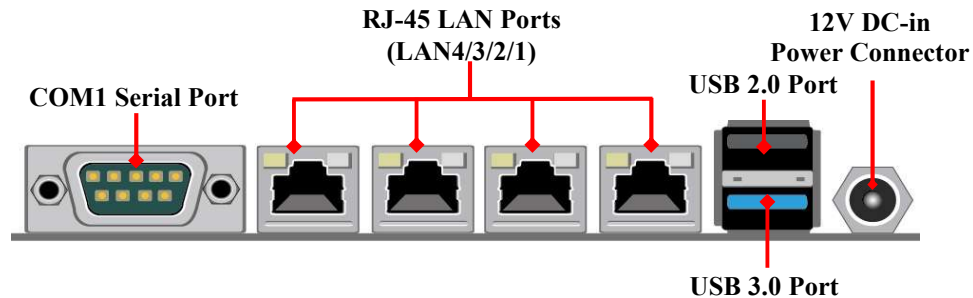

Warning!!

The board has a 12V DC-in power connector (DCIN) in I/O back panel and an internal ATX12V (ATX2P) power connector. User can only connect one type of compatible power supply to one of them to power the system.

Motherboard Internal Diagram-Front Side

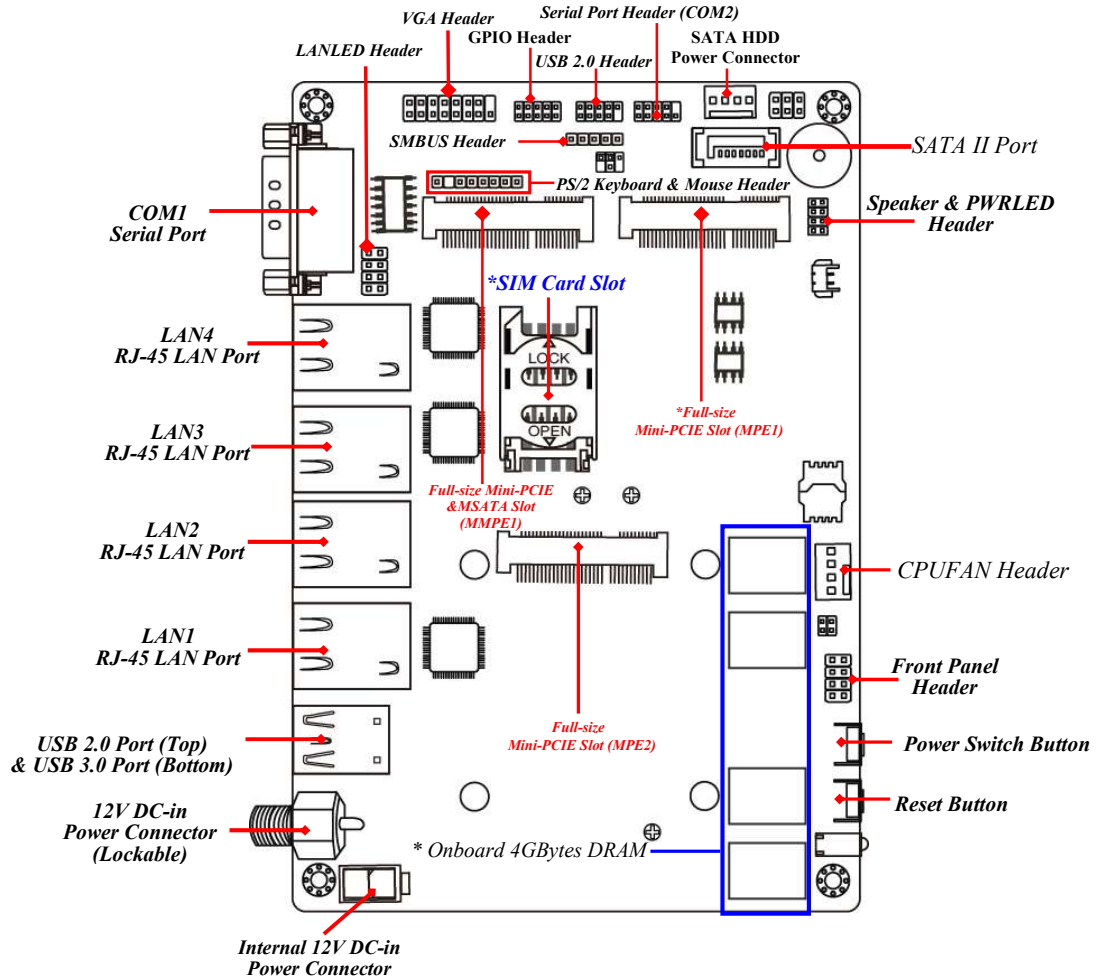

Note: SIM card slot only work when compatible SIM card installed & 3G LAN card installed in MPE1 Mini-PCIE slot.

Motherboard Internal Diagram-Back Side

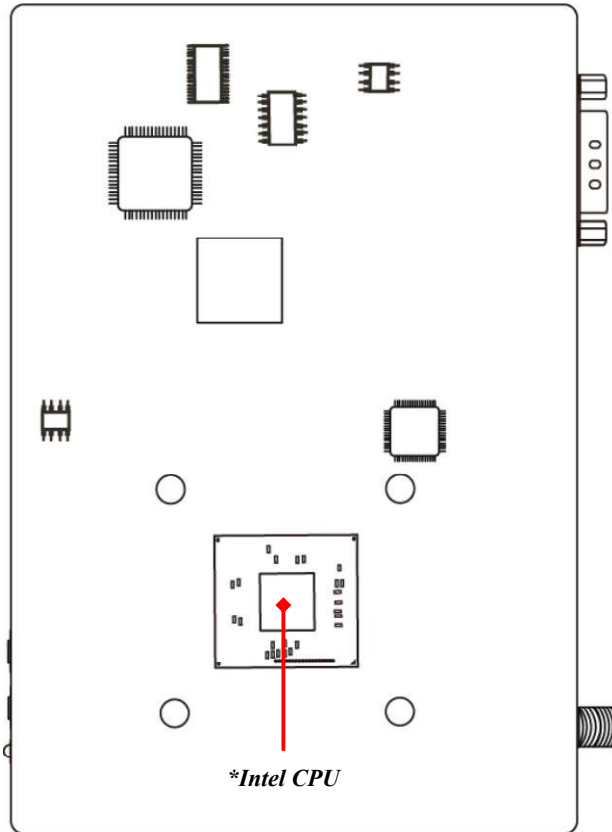

***Note:** CPU is the most important part of the board and very fragile to any possible harm. Make sure that there is no damage to the CPU during any installation procedures!

Jumper Position:

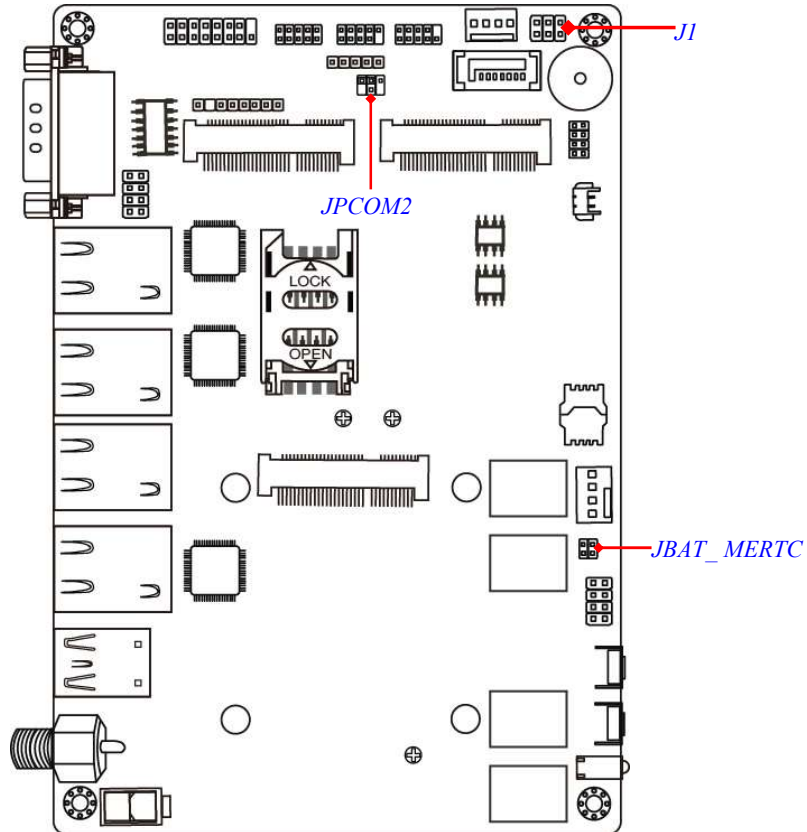

Jumper

Jumper	Name	Description
JBAT_MERTC	Pin (1&3): Clear ME Function Setting Pin (2&4): Clear CMOS RAM Function Setting	4-Pin Block
J1	Pin (1&2): ATX Mode / AT Mode Select Pin(3&4): Case Open Message Display Function Pin (5&6): ME Security Measure Function Select	6-Pin Block

JPCOM2	COM2 Header Pin9 Function Select	4-Pin Block
---------------	----------------------------------	-------------

Connectors

Connector	Name
DCIN	12V System DC-in Power Jack Connector
ATX2P	Internal 12V System DC-in Power Connector
USB1	Top: USB 2.0 Port Connector Bottom: USB 3.0 Port Connector
LAN1/2/3/4	RJ-45 LAN Port Connector x 4
VGA	Video Graphic Attach Connector
COM1	Serial Port Connector
CPUFAN1	CPUFAN Connector

Headers

Header	Name	Description
JW_FP	Front Panel Header(PWR LED/ HDD LED/Power Button /Reset)	8-pin Block
SPK-LED1	Power LED & Speaker Header	8-pin Block
LAN_LED	LAN Activity LED Header	8-pin Block
COM2	Serial Port Header	9-pin Block
FP_USB2	USB 2.0 Header	9-pin Block
PS2KBMS	PS/2 Keyboard & Mouse Header	6-pin Block
SMBUS	SMBUS Header	5-pin Block
GPIO_CON	GPIO Header	10-pin Block
VGA	VGA Port Header	15-pin Block

Chapter 2

Hardware Installation

2-1 Jumper Setting

Pin (1&3) of JBAT_MERTC (4-pin): Clear ME Function Setting

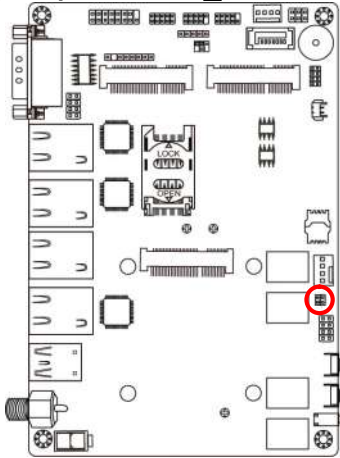

Pin(1&3) of JBAT_MERTC → Clear ME

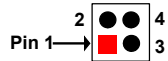

1-3 Open: Normal(Default);

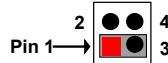

1-3 Closed: Clear ME.

Pin(2&4) of JBAT_MERTC (4-pin): Clear CMOS Setting

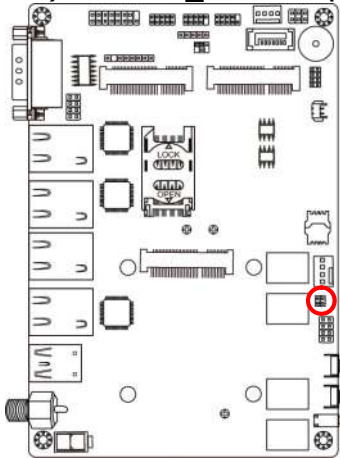

Pin (2&4) of JBAT_MERTC → Clear CMOS

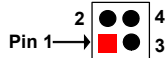

2-4 Open: Normal(Default);

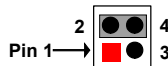

2-4 Closed: Clear CMOS(One Touch).

Pin (1&2) of J1 (6-pin): ATX Mode/AT Mode Select

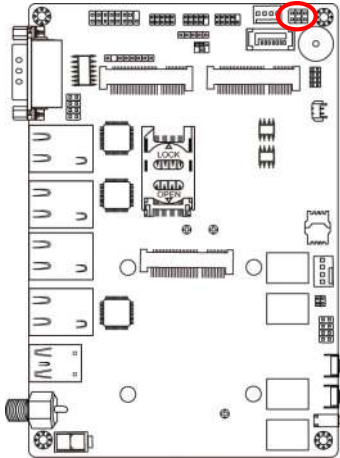

Pin (1&2) of J1 → ATX/AT Mode Select

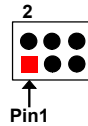

1-2 Open: ATX Mode Selected(Default);

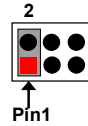

1-2 Closed: AT Mode Selected.

***ATX Mode Selected:** Press power button to power on after power input ready;
AT Mode Selected: Directly power on as power input ready.

Pin (3&4) of J1 (6pin): Case Open Message Display Function Select

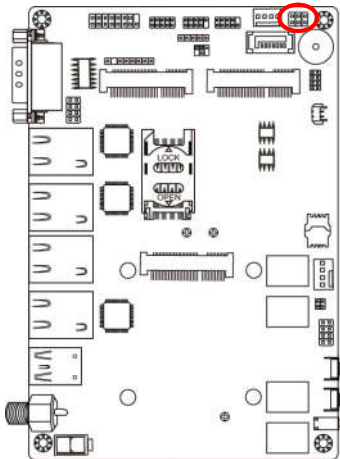

Pin (3&4) of J1 → Case Open

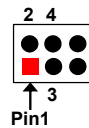

3-4 Open: Normal(Default);

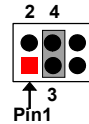

3-4 Closed: Case Open Function.

Pin (3&4) Closed: When Case open function pin short to GND, the Case open function was detected. When Used, needs to enter BIOS and enable 'Case Open Detect' function. In this case if your case is removed, next time when you restart your computer, a message will be displayed on screen to inform you of this.

Pin (5&6) of J1 (6-pin): ME Security Measure Function Select

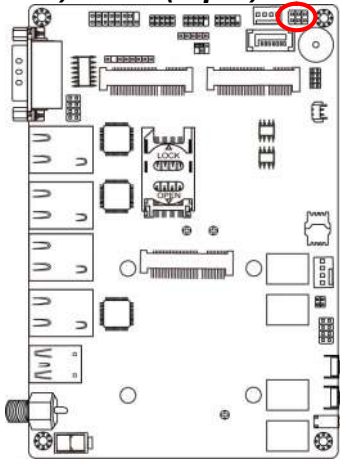

Pin (5&6) of J1 → ME Security Function Select

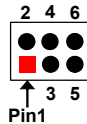

5-6 Open: Enable Security Measures in the Flash Descriptor(Default);

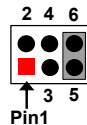

5-6 Closed: Disable Security Measures in the Flash Descriptor(Override).

JPCOM2 (4-pin): COM2 Header Pin9 Function Select

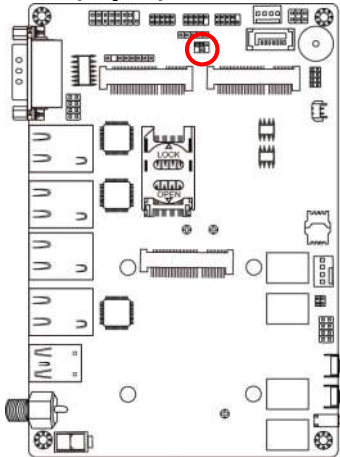

JPCOM2 → COM2 Header Pin-9

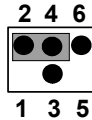

2-4 Closed:
Pin9= RI (Default);

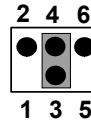

3-4 Closed:
Pin9=+5V;

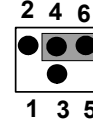





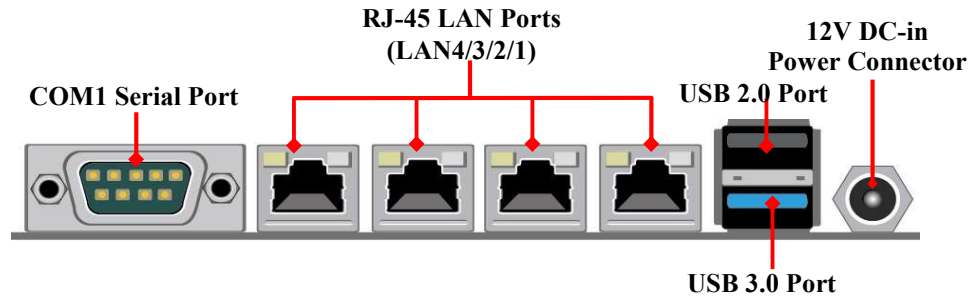

4-6 Closed:
Pin9=+12V.

2-2 Connectors and Headers

2-2-1 Connectors

(1) Rear I/O Connectors



Icon	Name	Function
	12V DC-in Power Connector	For user to connect compatible power adapter to provide power supply for the system.
	USB 2.0 Port	To connect USB keyboard, mouse or other devices compatible with USB specification.
	USB 3.0 Port	To connect USB keyboard, mouse or other devices compatible with USB specification. USB 3.0 ports supports up to 5Gbps data transfer rate.
	RJ-45 LAN Port	This connector is standard RJ-45 LAN jack for Network connection.
	RS232 Serial Port	Mainly for user to connect external MODEM or other devices that supports Serial Communications Interface.

(2) ATX2P (2-pin Block): Internal 12V DC-in Power Connector

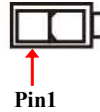
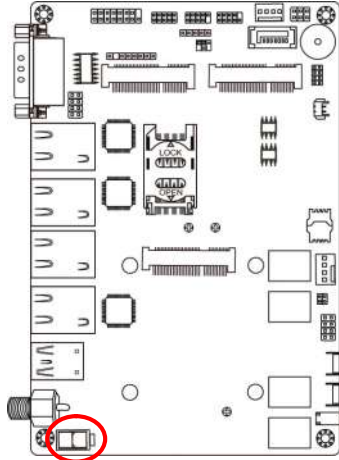

Pin.	Definition
1	GND
2	+12V DC_IN

(3) SATA1 (7-pin Block): SATAII Port connector

SATA1 port is a high-speed SATAII port that supports 3GB/s transfer rate.

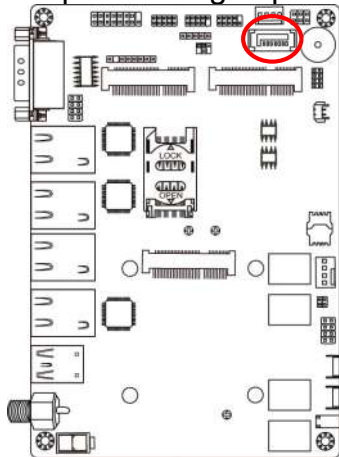

Pin No.	Definition
1	GND
2	TXP
3	TXN
4	GND
5	RXN
6	RXP
7	GND

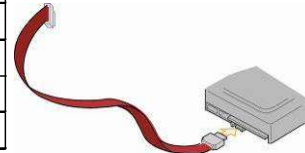

(4) SATAPW (4-pin): SATA Power Out Connector

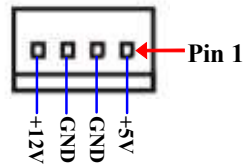
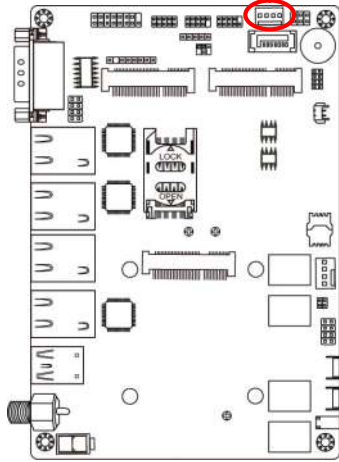

Warning: Make sure that Pin-1 of compatible SATA Power connector is inserted into corresponding Pin-1 of SATAPW to avoid possible damage to the board and hard disk driver!

(5) CPUFAN (4-pin): CPUFAN Connector

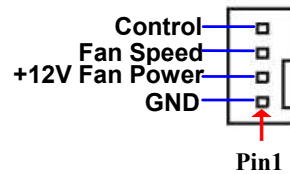
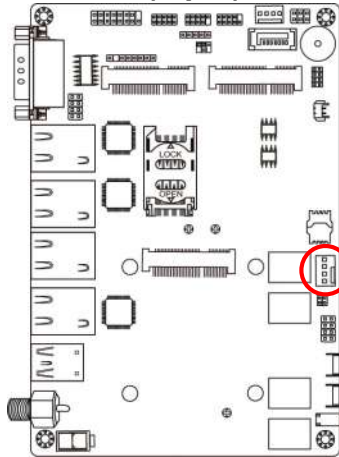

2-2-2 Headers

(1) JW_FP (8-pin): Front Panel Header

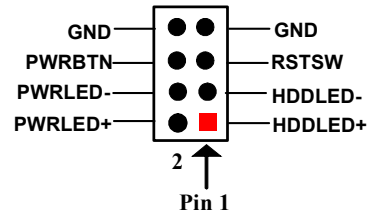
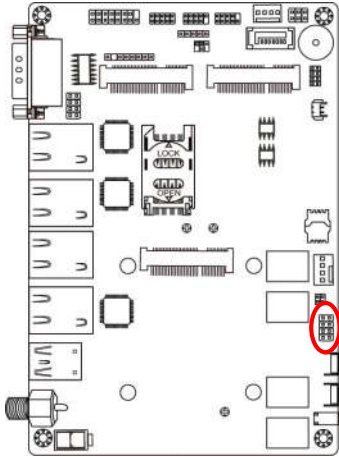

(2) SPK-LED1 (8-pin): Speaker & Power LED Header

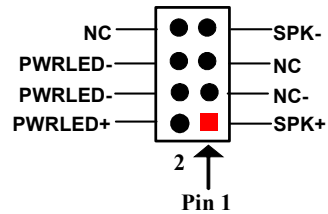
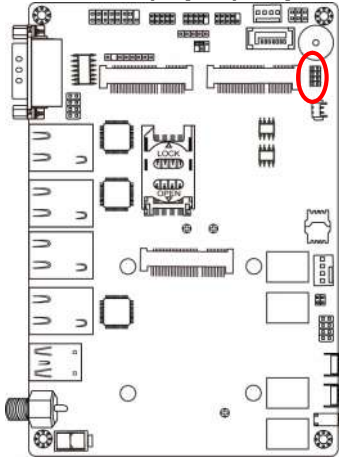

(3) LAN_LED (8-pin): LAN Activity LED Header

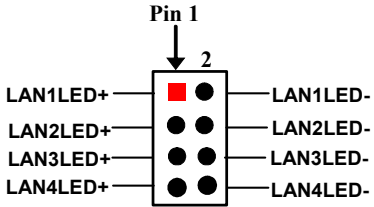
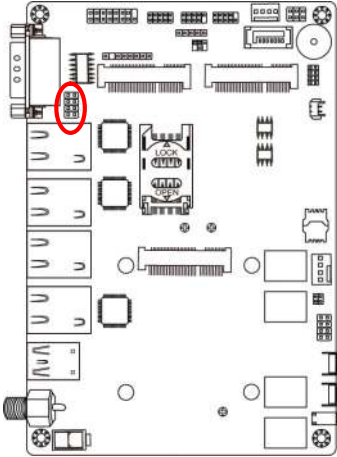

(4) FP_USB2 (9-pin): USB 2.0 Port Header

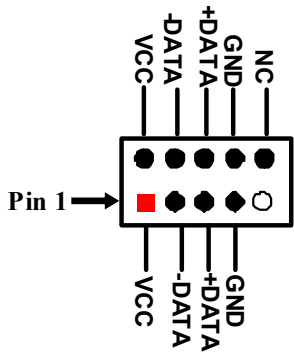
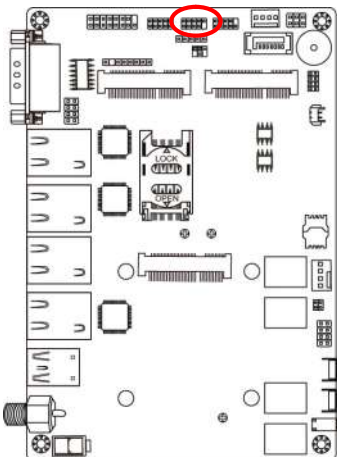

(5) COM2 (9-pin): RS232(/422/485) Serial Port Header

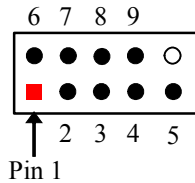
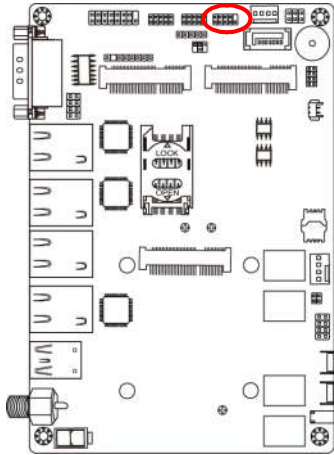

Pin NO.	RS232	*RS422 <i>(optional)</i>	*RS485 <i>(optional)</i>
Pin 1	DCD	TX-	DATA-
Pin 2	RXD	TX+	DATA+
Pin 3	TXD	RX+	NC
Pin 4	DTR	RX-	NC
Pin 5	GND	GND	GND
Pin 6	DSR	NC	NC
Pin 7	RTS	NC	NC
Pin 8	CTS	NC	NC
Pin 9	RI	NC	NC

***Notice:** COM2 servers as RS232 serial port header in most cases. RS422 & RS485 function is only optional to customized models. User also needs to go to BIOS to set '**Transmission Mode Select**' for COM2 as [RS422] or [RS485] for boards that support RS422/485 function before connecting compatible COM cable to COM2 header.

(6) PS2KBMS (6-pin): PS2 Keyboard & Mouse Header

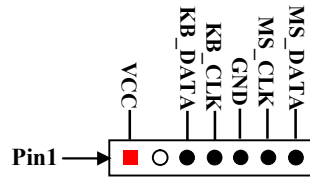
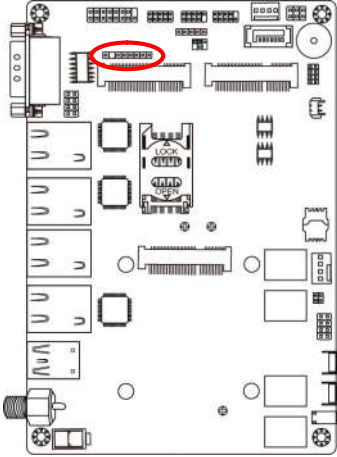

(7) SMBUS (5-Pin): SM BUS Header

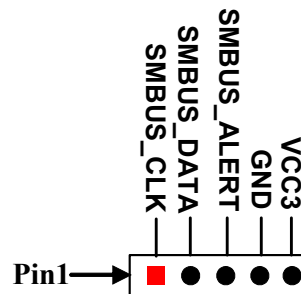
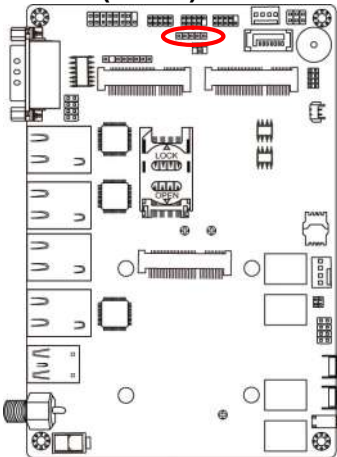

(8) GPIO_CON (10-pin): GPIO Header

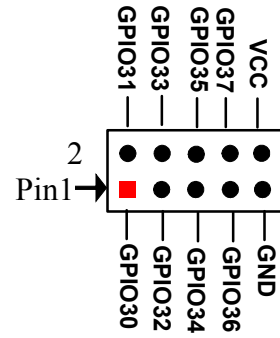
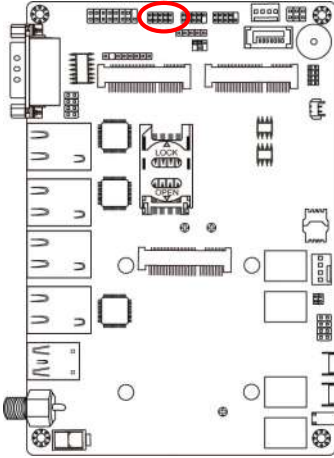

(9) FP_VGA(15-pin): VGA Port Header

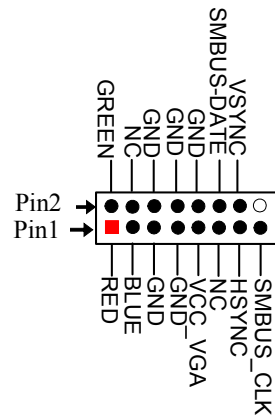
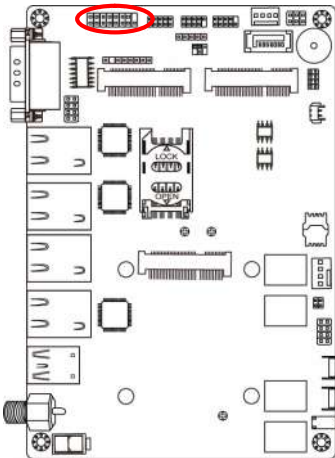

Chapter 3

Introducing BIOS

Notice! The BIOS options in this manual are for reference only. Different configurations may lead to difference in BIOS screen and BIOS screens in manuals are usually the first BIOS version when the board is released and may be different from your purchased motherboard. Users are welcome to download the latest BIOS version form our official website.

The BIOS is a program located on a Flash Memory on the motherboard. This program is a bridge between motherboard and operating system. When you start the computer, the BIOS program will gain control. The BIOS first operates an auto-diagnostic test called POST (power on self test) for all the necessary hardware, it detects the entire hardware device and configures the parameters of the hardware synchronization. Only when these tasks are completed done it gives up control of the computer to operating system (OS). Since the BIOS is the only channel for hardware and software to communicate, it is the key factor for system stability, and in ensuring that your system performance as its best.

3-1 Entering Setup

Power on the computer and by pressing immediately allows you to enter Setup. If the message disappears before your respond and you still wish to enter Setup, restart the system to try again by turning it OFF then ON or pressing the “RESET” button on the system case. You may also restart by simultaneously pressing <Ctrl>, <Alt> and <Delete> keys. If you do not press the keys at the correct time and the system does not boot, an error message will be displayed and you will again be asked to

Press **** to enter Setup; press **< F7>** to enter pop-up Boot menu.

3-2 BIOS Menu Screen

The following diagram show a general BIOS menu screen:

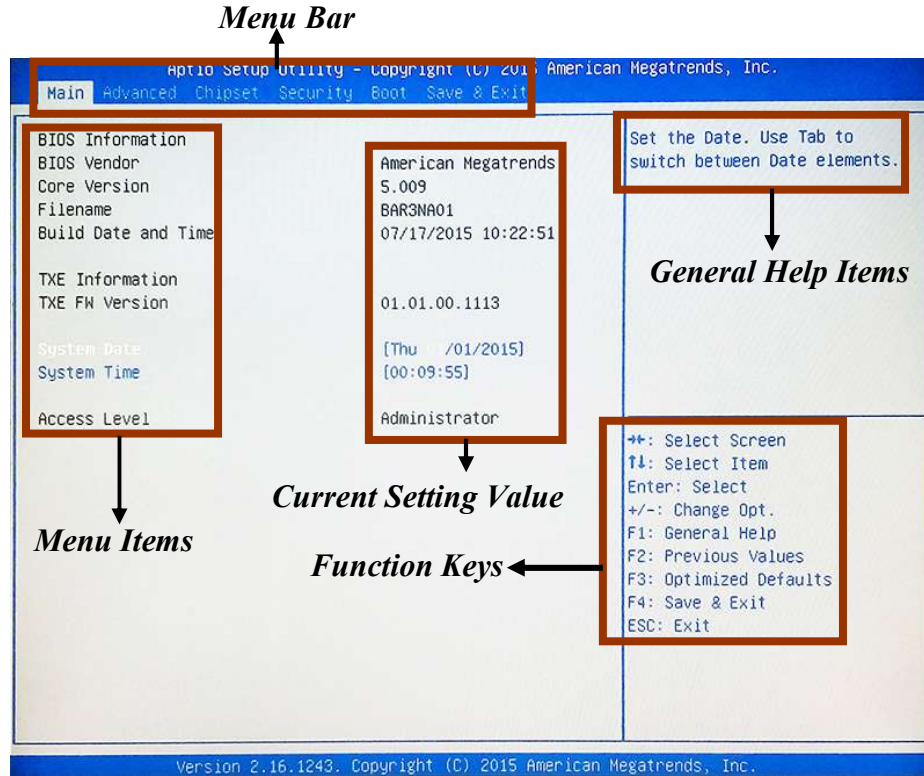

3-3 Function Keys

In the above BIOS Setup main menu of, you can see several options. We will explain these options step by step in the following pages of this chapter, but let us first see a short description of the function keys you may use here:

- Press ←→ (left, right) to select screen;
- Press ↑↓ (up, down) to choose, in the main menu, the option you want to confirm or to modify.

-
-
- Press <Enter> to select.
 - Press <+>/<-> keys when you want to modify the BIOS parameters for the active option.
 - [F1]: General help.
 - [F2]: Previous value.
 - [F3]: Optimized defaults.
 - [F4]: Save & Exit.
 - [F7]: To enter pop-up boot menu to select boot device.
 - Press <Esc> to quit the BIOS Setup.

3-4 Getting Help

Main Menu

The on-line description of the highlighted setup function is displayed at the top right corner the screen.

Status Page Setup Menu/Option Page Setup Menu

Press [F1] to pop up a small help window that describes the appropriate keys to use and the possible selections for the highlighted item. To exit the Help Window, press <Esc>.

3-5 Menu Bars

There are six menu bars on top of BIOS screen:

Main	To change system basic configuration
Advanced	To change system advanced configuration
Chipset	To change chipset configuration
Security	Password settings
Boot	To change boot settings
Save & Exit	Save setting, loading and exit options.

User can press the right or left arrow key on the keyboard to switch from menu bar. The selected one is highlighted.

3-6 Main Menu

Main menu screen includes some basic system information. Highlight the item and then use the <+> or <-> and numerical keyboard keys to select the value you want in each item.

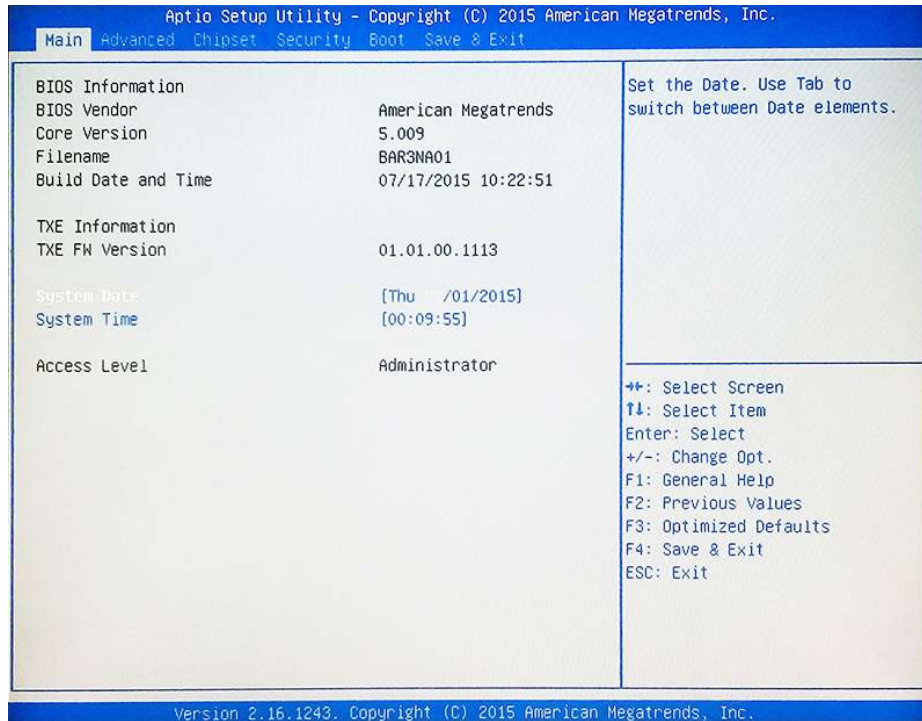

System Date

Set the date. Please use [Tab] to switch between data elements.

System Time

Set the time. Please use [Tab] to switch between time elements.

3-7 Advanced Menu

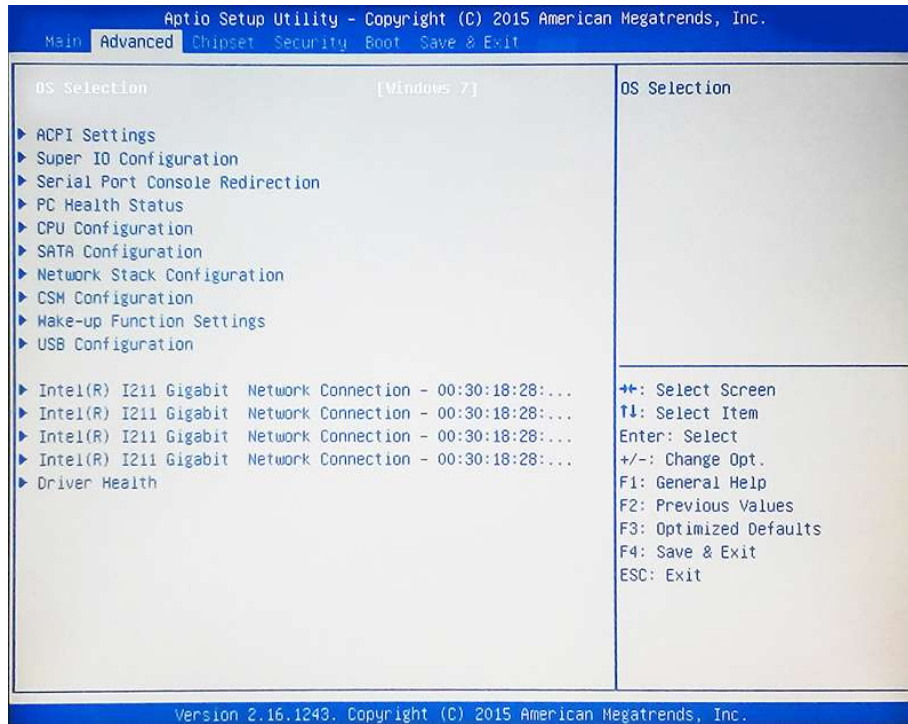

OS Selection

The optional settings: [Windows 8.X]; [Android]; [Windows 7].

***Note:** User needs to go to this item to select OS before installing OS.

If Windows Embedded standard 8, please select [Windows 8x] and set "USB 3.0 Support" as [Disabled], "USB 2.0 Support" as [Enabled] (refer to Page 33).

▶ **ACPI Settings**

Press [Enter] to make settings for the following sub-item:

ACPI Settings

ACPI Sleep State

Use this item to select the highest ACPI sleep state the system will enter when the

suspend button is pressed.

The optional settings are: [Suspend Disabled]; [S3 (Suspend to RAM)].

▶ **Super I/O Configuration**

Press [Enter] to make settings for the following sub-items:

Super IO Configuration

▶ **Serial Port 1 Configuration/ Serial Port 2 Configuration**

Press [Enter] to make settings for the following items:

Serial Port

Use this item to enable or disable serial port (COM).

Change Settings

Use this item to select an optimal setting for super IO device.

Serial Port FIFO Mode

The optional settings are: [16-Byte FIFO]; [32-Byte FIFO]; [64-Byte FIFO]; [128-Byte FIFO].

ERP Support

The optional settings: [Disabled]; [Enabled].

This item should be set as [Disabled] if you wish to have all active wake-up functions.

Case Open Detect

This item controls detect case open function.

The optional settings: [Disabled]; [Enabled].

WatchDog Reset Timer

Use this item to enable or disable WatchDog Timer reset function. When set as [Enabled], the following sub-items shall appear:

WatchDog Reset Timer Value

User can set a value in the range of [10] to [255].

WatchDog Reset Timer Unit

The optional settings are: [Sec.]; [Min.].

WatchDog Wake-up Timer

This item support WDT wake-up while ERP function is set as [Enabled].

The optional settings: [Disabled]; [Enabled].

When set as [Enabled], the following sub-items shall appear:

WatchDog Wake-up Timer Value

The setting range is [10] ~ [4095] seconds, or [1] ~ [4095] minutes.

WatchDog Wake-up Timer Unit

The optional settings are: [Sec.]; [Min.].

ATX Power Emulate AT Power

This item displays current Emulate AT Power Status, motherboard power On/Off control by power supply. User needs to select 'ATX/AT Mode' on MB jumper at first (refer to **Page 9, Pin (1&2) of J1** for ATX Mode /AT Mode Select).

▶ **Serial Port Console Redirection**

Press [Enter] to make settings for the following sub-items:

COM1/COM2

Console Redirection

Use this item to enable or disable COM1/COM2 Console Redirection.

The optional settings are: [Disabled]; [Enabled].

When set as [Enabled], user can make further settings in the 'Console Redirection Settings' screen:

▶ **Console Redirection Settings**

The settings specify how the host computer and the remote computer (which the user is using) will exchange data. Both computers should have the same or compatible settings.

Press [Enter] to make settings for the following sub-items.

Terminal Type

The optional settings are: [VT100]; [VT100+]; [VT-UTF8]; [ANSI].

Bits per second

The optional settings are: [9600]; [19200]; [38400]; [57600]; [115200].

Data Bits

The optional settings are: [7]; [8].

Parity

The optional settings are: [None]; [Even]; [Odd];[Mark]; [Space].

Stop Bits

The optional settings are: [1]; [2].

Flow Control

The optional settings are: [None]; [Hardware RTS/CTS].

VT-UTF8 Combo Key Support

The optional settings are:[Disabled]; [Enabled].

Recorder Mode

The optional settings are: [Disabled]; [Enabled].

Resolution 100x31

The optional settings are:[Disabled]; [Enabled].

Legacy OS Redirection Resolution

The optional settings are: [80x24]; [80x25].

Putty Keypad

The optional settings are: [VT100]; [LINUX]; [XTERMR6]; [SCO]; [ESCN]; [VT400].

Redirection After BIOS POST

The optional settings are: [Always Enable]; [BootLoader].

Serial Port for Out-of-Band Management/

Windows Emergency Management Services (EMS)

Console Redirection

The optional settings: [Disabled]; [Enabled].

When set as [Enabled], user can make further settings in '**Console Redirection Settings**':

▶ Console Redirection Settings

The settings specify how the host computer and the remote computer (which the user is using) will exchange data. Both computers should have the same or compatible settings.

Press [Enter] to make settings for the following sub-items.

Out-of-Band Mgmt Port

The optional settings are: [COM1]; [COM2].

Terminal Type

The optional settings are: [VT100]; [VT100+]; [VT-UTF8]; [ANSI].

Bits per second

The optional settings are: [9600]; [19200]; [57600]; [115200].

Flow Control

The optional settings are: [None]; [Hardware RTS/CTS]; [Software Xon/Xoff].

Data Bits

The default setting is: [8].

**This item may or may not show up, depending on different configuration.*

Parity

The default setting is: [None].

**This item may or may not show up, depending on different configuration.*

Stop Bits

The default setting is: [1].

**This item may or may not show up, depending on different configuration.*

▶ **PC Health Status**

Press [Enter] to view current hardware health status, set shutdown temperature, or make further settings in '**Smart Fan Configuration**'.

▶ **SmartFAN Configuration**

Press [Enter] to make settings for '**SmartFAN Configuration**':

CPUFAN Smart Mode

The optional settings: [Disabled]; [Enabled].

When set as [Enabled], the following sub-items shall appear:

CPUFAN Full-Speed Temperature

Use this item to set CPUFAN full speed temperature. Fan will run at full speed when above the preset temperature.

CPUFAN Full-Speed Duty

Use this item to set CPUFAN full speed duty. Fan will run at full speed when above the pre-set duty.

CPUFAN Idle-Speed Temperature

Use this item to set CPUFAN idle speed temperature. Fan will run at idle speed when below the pre-set temperature.

CPUFAN Idle-Speed Duty

Use this item to set CPUFAN idle speed duty. Fan will run at idle speed when below the pre-set duty.

Shutdown Temperature Configuration

Use this item to select system shutdown temperature.

The optional settings are: [Disabled]; [70°C/156°F]; [75°C/164°F]; [80°C/172°F]; [85°C/180°F]; [90°C/188°F].

▶ **CPU Configuration**

Press [Enter] to view current CPU configuration and make settings for the following sub-items:

Limit CPUID Maximum

The optional settings: [Disabled]; [Enabled].

This item should be set as [Disabled] for Windows XP.

Execute Disable Bit

The optional settings: [Disabled]; [Enabled].

Hardware Prefetcher

The optional settings are: [Disabled]; [Enabled].

Use this item to turn on/off the Mid Level Cache (L2) streamer prefetcher.

Adjacent Cache Line Prefetch

The optional settings are: [Disabled]; [Enabled].

Use this item to turn on/off prefetching of adjacent cache lines.

Intel Virtualization Technology

The optional settings: [Enabled]; [Disabled].

When set as [Enabled], a VMM can utilize the additional hardware capabilities provided by Vanderpool Technology.

EIST

The optional settings: [Disabled]; [Enabled].

Use this item to enable or disable Intel SpeedStep.

Max CPU C State

This item controls Max C state that the processor will support.
The optional settings: [C7]; [C6]; [C1].

▶ **SATA Configuration**

Press [Enter] to make settings for the following sub-items:

SATA Configuration

SATA Controller

The optional settings are: [Enabled]; [Disabled].

When set as [Enabled], the following items shall appear:

SATA Speed Support

The item is for user to set the maximum speed the SATA controller can support.

The optional settings are: [Gen1]; [Gen2].

SATA Mode

The optional settings are: [IDE Mode]; [AHCI Mode].

SATA Port1/ m-SATA

The optional settings are: [Enabled]; [Disabled].

▶ **Network Stack Configuration**

Press [Enter] to go to '**Network Stack**' screen to make further settings.

Network Stack

The optional settings are: [Enabled]; [Disabled].

When set as [Enabled], the following sub-items shall appear:

Ipv4 PXE Support

The optional settings are: [Disabled]; [Enabled].

Use this item to enable Ipv4 PXE Boot Support. When set as [Disabled], Ipv4 boot optional will not be created.

Ipv6 PXE Support

The optional settings are: [Disabled]; [Enabled].

Use this item to enable Ipv6 PXE Boot Support. When set as [Disabled], Ipv6 boot optional will not be created.

PXE boot wait time

Use this item to set wait time to press [ESC] key to abort the PXE boot.

▶ **CSM Configuration**

Press [Enter] to make settings for the following sub-items:

Compatibility Support Module Configuration

Boot Option Filter

This item controls Legacy/UEFI ROMs priority.

The optional settings are: [UEFI and Legacy]; [Legacy only]; [UEFI only].

Network

This item controls the execution of UEFI and legacy PXE OpROM.

The optional settings are: [Do not launch]; [UEFI only]; [Legacy only].

Storage

This item controls the execution of UEFI and Legacy Storage OpROM.

The optional settings are: [Do not launch]; [UEFI only]; [Legacy only].

Other PCI devices

This item determines OpROM execution policy for devices other than Network, storage or video.

The optional settings are: [UEFI first]; [Legacy first].

▶ **Wake-up Function Settings**

Press [Enter] to make settings for the following sub-items:

Wake-up System with Fixed Time

Use this item to enable or disable system wake-up by RTC alarm.

The optional settings: [Disabled]; [Enabled].

When set as [Enabled], system will wake on the hour/min/sec specified.

Wake-up System with Dynamic Time

Use this item to enable or disable system wake-up by RTC alarm.

The optional settings: [Disabled]; [Enabled].

When set as [Enabled], system will wake on the current time + increased minute(s). The settings range is from [1] ~ [60] minute(s).

USB(S3-S4)/PS2(S3-S5) Wake-up

Use this item to enable or disable USB Wake-up from S3-S4/PS/2 device wake up from S3-S5.

The optional settings: [Disabled]; [Enabled].

**USB Wake-up is affected by ERP function in S4. Please set 'ERP Support' as [Disabled] before activating this function in S4.*

▶ **USB Configuration**

Press [Enter] to make settings for the following sub-items:

USB Configuration

Legacy USB Support

The optional settings are: [Enabled]; [Disabled]; [Auto].

[Enabled]: To enable legacy USB support.

[Disabled]: To keep USB devices available only for EFI specification,

[Auto]: To disable legacy support if no USB devices are connected.

XHCI Hand-off

This is a workaround for OSes without XHCI hand-off support. The XHCI ownership change should be claimed by XHCI driver.

The optional settings are: [Enabled]; [Disabled].

EHCI Hand-off

This is a workaround for OSes without EHCI hand-off support. The EHCI ownership change should be claimed by EHCI driver.

The optional settings are: [Disabled]; [Enabled].

USB Mass Storage Driver Support

The optional settings are: [Disabled]; [Enabled].

USB Hardware Delays and Time-outs:

USB Transfer Time-out

Use this item to set the time-out value for control, bulk, and interrupt transfers.

The optional settings are: [1 sec]; [5 sec]; [10 sec]; [20 sec].

Device Reset Time-out

Use this item to set USB mass storage device start unit command time-out.

The optional settings are: [10 sec]; [20 sec]; [30 sec]; [40 sec].

Device Power-up Delay

Use this item to set maximum time the device will take before it properly reports itself to the host controller.

The optional settings: [Auto]; [Manual].

[**Auto**]: uses default value: for a root port it is 100 ms, for a hub port the delay is taken from hub descriptor.

Select [**Manual**] you can set value for the following sub-item: '**Device Power-up Delay in Seconds**'.

Device Power-up Delay in Seconds

The delay range is from [1] to [40] seconds, in one second increments.

▶ **Intel(R) I211 Gigabit Network Connection- XX:XX:XX:XX:XX:XX**

Press [Enter] to view current network information and make further settings in '**NIC Configuration**'

▶ **NIC Configuration**

Press [Enter] to configure the network device port.

Link Speed

Use this item to specify the port speed used for the selected boot protocol.

The optional settings are: [Auto Negotiated]; [10 Mbps Half]; [10 Mbps Full]; [100 Mbps Half]; [100 Mbps Full].

Wake On LAN

Use this item to enable the server to be powered on using an in-hand magic packet.

Blink LEDs

Use this item to identify the physical network port by blinking the associated LED.

▶ **Driver Health**

Press [Enter] to view health status for the drivers/controllers.

3-8 Chipset Menu

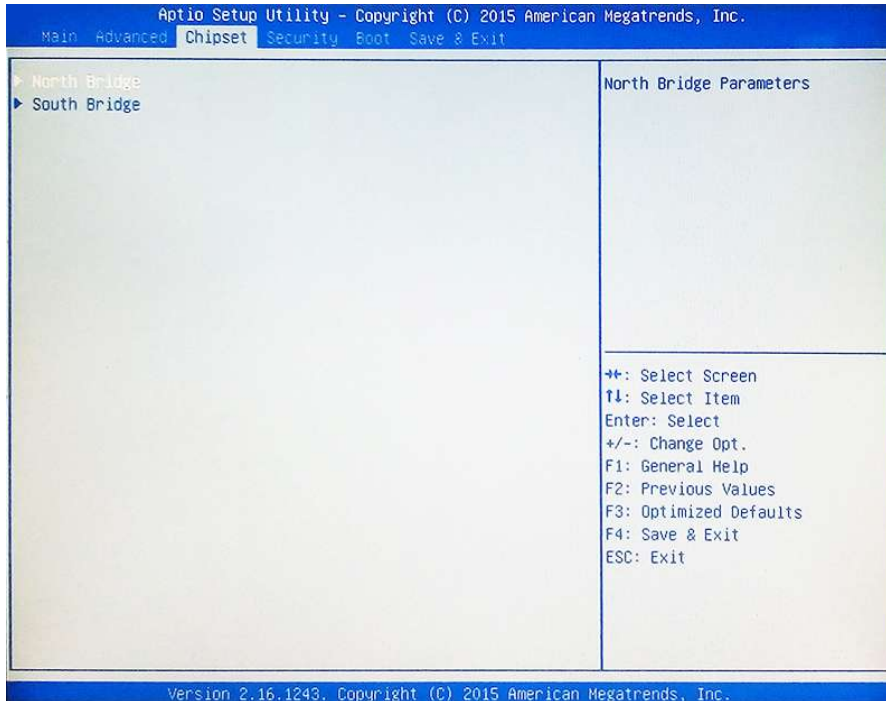

▶ **North Bridge**

Press [Enter] to make settings for the following sub-items:

PAVC

Use this item to enable or disable protected audio video control.

The optional settings are: [Disabled]; [LITE Mode]; [SERPENT Mode].

DVMT Pre-Allocated

Use this item to select DVMT 5.0 pre-allocated (fixed) graphics memory size used by the internal graphics device.

The optional settings are: [64M]; [96M]; [128M]; [160M]; [192M]; [224M]; [256M]; [288M]; [320M]; [352M]; [384M]; [416M]; [448M]; [480M]; [512M].

DVMT Total Gfx Mem

Use this item to select DVMT 5.0 total graphics memory size used by the internal graphics device.

The optional settings are: [128M]; [256M]; [MAX].

Aperture Size

The optional settings are: [128MB]; [256MB]; [512MB].

GTT Size

The optional settings are: [1MB]; [2MB].

▶ **South Bridge**

Press [Enter] to make further settings in south bridge parameters.

Mini PCIE1/Mini PCIE2

The optional settings are: [Enabled]; [Disabled].

Onboard PCIE LAN1/ Onboard PCIE LAN2/ Onboard PCIE LAN3/ Onboard PCIE LAN4

The optional settings are: [Enabled]; [Disabled].

▶ **USB Configuration**

Press [Enter] to make settings for the following sub-items:

USB Configuration

USB 3.0 Support

The optional settings are: [Enabled]; [Auto]; [Disabled].

USB 2.0 Support

The optional settings are: [Enable]; [Disabled].

**This item may or may not show up, depending on different configuration.*

System State after Power Failure

Use this item to select AC power state when power is re-applied after a power failure.

The optional settings are: [Always Off]; [Always On]; [Former State].

** The option [Always On] and [Former State] are affected by ERP function. Please disable ERP to support [Always On] and [Former State] function.*

3-9 Security Menu

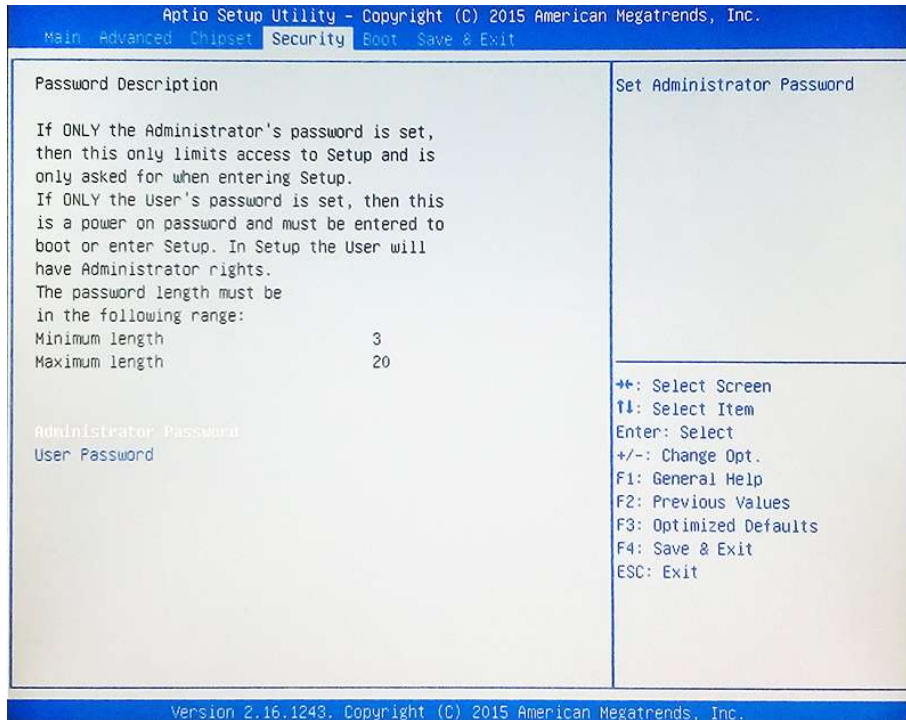

Security menu allow users to change administrator password and user password settings.

3-10 Boot Menu

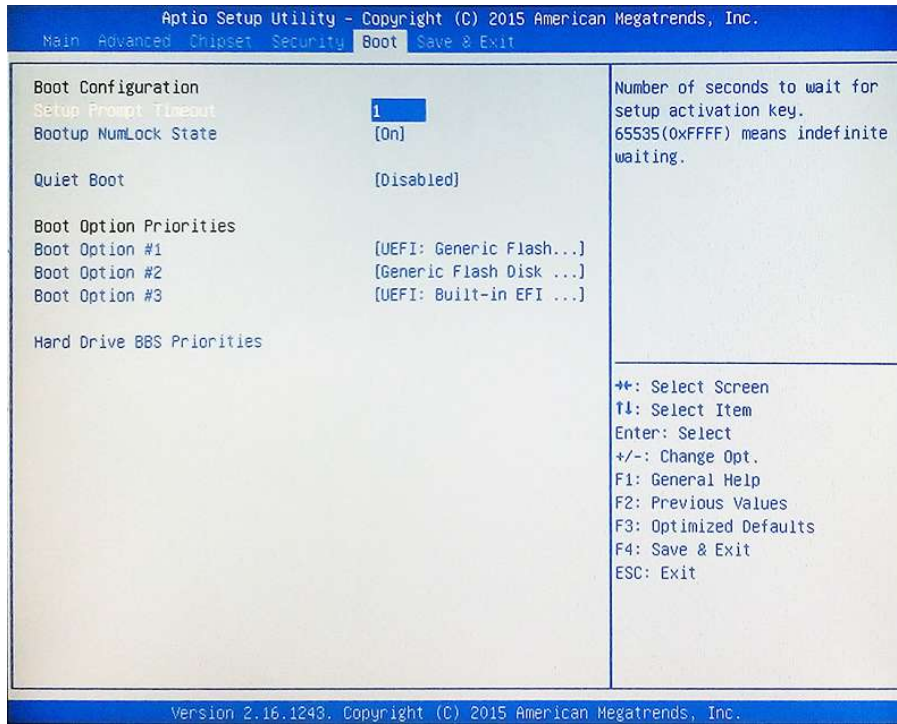

Boot Configuration

Setup Prompt Timeout

Use this item to set number of seconds to wait for setup activation key.

Bootup Numlock State

Use this item to select keyboard numlock state.

The optional settings are: [On]; [Off].

Quiet Boot

The optional settings are: [Disabled]; [Enabled].

Boot Option Priorities

Boot Option #1/ Boot Option #2...

Use this item to decide system boot order from available options.

Hard Drive BBS Priorities

Use this item to set the system boot order of the legacy device in the group.

3-11 Save & Exit Menu

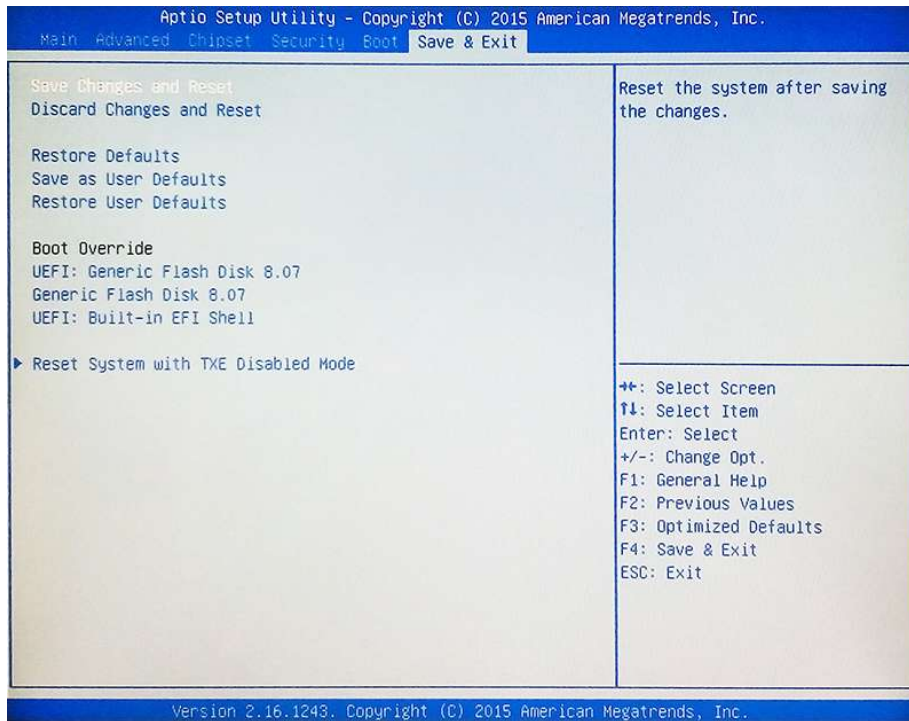

Save Changes and Reset

This item allows user to reset the system after saving the changes.

Discard Changes and Reset

This item allows user to reset the system without saving any changes.

Restore Defaults

Use this item to restore /load default values for all the setup options.

Save as User Defaults

Use this item to save the changes done so far as user defaults.

Restore User Defaults

Use this item to restore the user defaults to all the setup options.

Boot Override

Boot Override

UEFI:xx/...

Press this item to select the device as boot disk after save configuration and reset.

Reset System with TXE disable Mode

Press [Enter] for TXE to run into the temporary disable mode. Ignore if TXE Ignition FM.